

SOP-8L Dual -30V P-Channel PowerTrench[®] MOSFET

SI4953

SI4953 Dual P-Channel -30V(D-S) MOSFET

$V_{(BR)DSS}$	$R_{DS(on)MAX}$	I_D
-30V	0.059Ω@-10V	-5.3A
	0.089Ω@-4.5V	

General FEATURE

- TrenchFET Power MOSFET
- Lead free product is acquired
- Surface mount package

APPLICATION

- Load Switch for Portable Devices
- DC/DC Converter

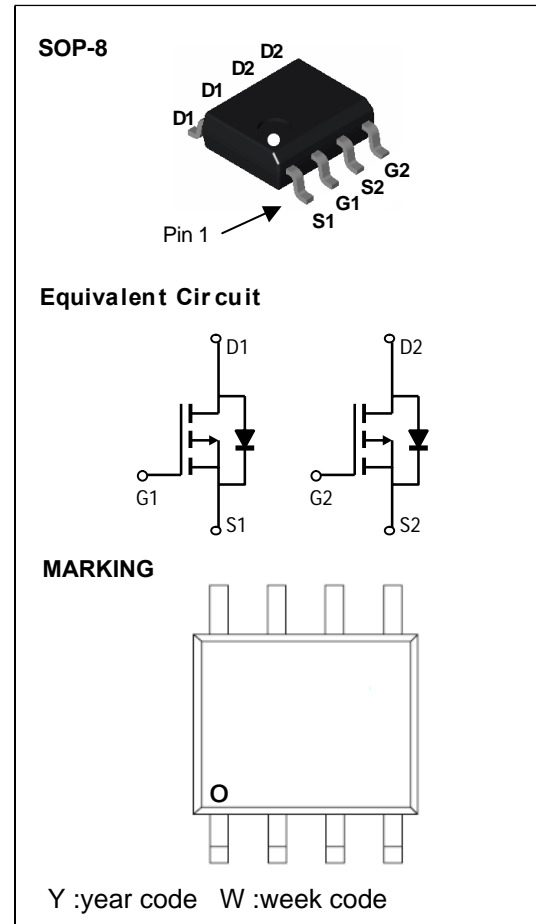

Maximum ratings ($T_a=25^{\circ}\text{C}$ unless otherwise noted)

Parameter	Symbol	Value	Unit
Drain-Source Voltage	V_{DS}	-30	V
Gate-Source Voltage	V_{GS}	±20	
Continuous Drain Current	I_D	-5.3	A
Pulsed Drain Current	I_{DM}	-20	
Maximum Power Dissipation	P_D	2.0	W
Thermal Resistance from Junction to Ambient($t \leq 5s$)	$R_{\theta JA}$	125	$^{\circ}\text{C}/\text{W}$
Junction Temperature	T_J	150	$^{\circ}\text{C}$
Storage Temperature	T_{stg}	-55 ~+150	

SOP-8L Dual 20V P-Channel PowerTrench[®] MOSFET
SI4953
Electrical Characteristics $T_A = 25^\circ\text{C}$ unless otherwise noted

Symbol	Parameter	Test Conditions	Min	Typ	Max	Units
Off Characteristics						
BV_{DSS}	Drain–Source Breakdown Voltage	$V_{GS} = 0\text{ V}, I_D = -250\ \mu\text{A}$	-30			V
I_{DSS}	Zero Gate Voltage Drain Current	$V_{DS} = -24\text{ V}, V_{GS} = 0\text{ V}$			-1	μA
I_{GSSF}	Gate–Body Leakage, Forward	$V_{GS} = -20\text{ V}, V_{DS} = 0\text{ V}$			-100	nA
I_{GSSR}	Gate–Body Leakage, Reverse	$V_{GS} = 20\text{ V}, V_{DS} = 0\text{ V}$			100	nA
On Characteristics						
$V_{GS(th)}$	Gate Threshold Voltage	$V_{DS} = V_{GS}, I_D = -250\ \mu\text{A}$	-1	-1.7	-3	V
$R_{DS(on)}$	Static Drain–Source On–Resistance	$V_{GS} = -10\text{ V}, I_D = -5.3\text{ A}$		54	59	m Ω
		$V_{GS} = -4.5\text{ V}, I_D = -4.2\text{ A}$		84	89	
$I_{D(on)}$	On–State Drain Current	$V_{GS} = -10\text{ V}, V_{DS} = -5.0\text{ V}$	-20			A
g_{FS}	Forward Transconductance	$V_{DS} = -5\text{ V}, I_D = -5\text{ A}$		10		S
Dynamic Characteristics						
C_{iss}	Input Capacitance	$V_{DS} = -15\text{ V}, V_{GS} = 0\text{ V},$ $f = 1.0\text{ MHz}$		528		pF
C_{oss}	Output Capacitance			132		pF
C_{rss}	Reverse Transfer Capacitance			70		pF
Switching Characteristics						
$t_{d(on)}$	Turn–On Delay Time	$V_{DD} = -15\text{ V}, I_D = -1\text{ A},$ $V_{GS} = -10\text{ V}, R_{GEN} = 6\ \Omega$		7		ns
t_r	Turn–On Rise Time			13		ns
$t_{d(off)}$	Turn–Off Delay Time			14		ns
t_f	Turn–Off Fall Time			9		ns
Q_g	Total Gate Charge	$V_{DS} = -15\text{ V}, I_D = -5\text{ A},$ $V_{GS} = -5\text{ V}$		6.0	9	nC
Q_{gs}	Gate–Source Charge			2.2		nC
Q_{gd}	Gate–Drain Charge			2.0		nC
Drain–Source Diode Characteristics and Maximum Ratings						
I_S	Maximum Continuous Drain–Source Diode Forward Current				-1.3	A
V_{SD}	Drain–Source Diode Forward Voltage	$V_{GS} = 0\text{ V}, I_S = -2.6\text{ A}$		-0.8	-1.2	V

Notes:

1. $R_{\theta JA}$ is the sum of the junction-to-case and case-to-ambient thermal resistance where the case thermal reference is defined as the solder mounting surface of the drain pins. $R_{\theta JC}$ is guaranteed by design while $R_{\theta CA}$ is determined by the user's board design.

Typical Characteristics

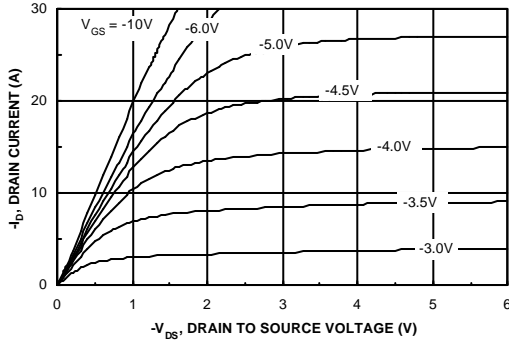

Figure 1. On-Region Characteristics.

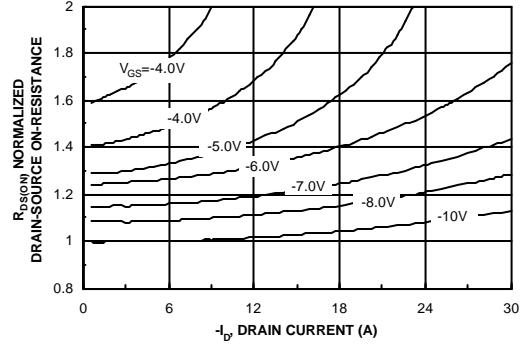

Figure 2. On-Resistance Variation with Drain Current and Gate Voltage.

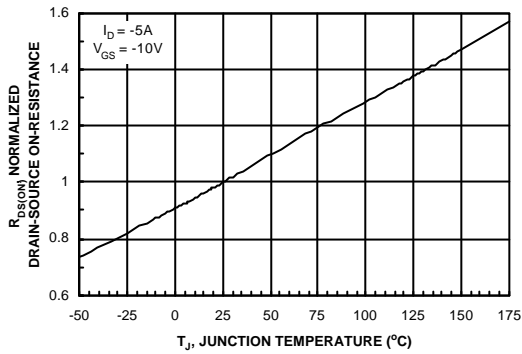

Figure 3. On-Resistance Variation with Temperature.

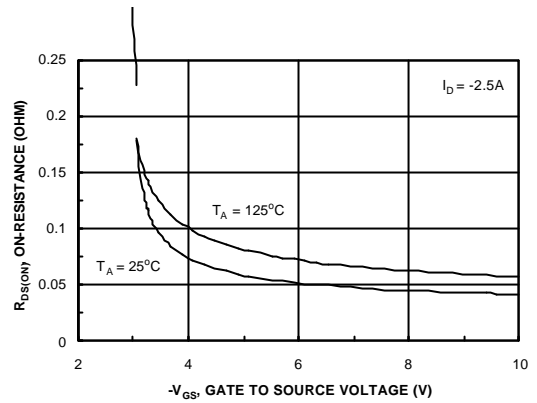

Figure 4. On-Resistance Variation with Gate-to-Source Voltage.

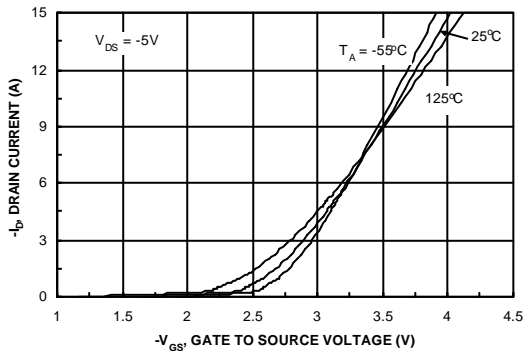

Figure 5. Transfer Characteristics.

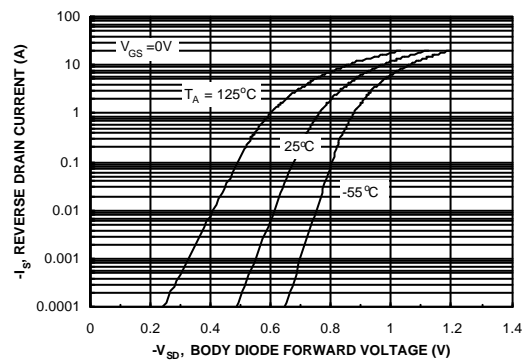

Figure 6. Body Diode Forward Voltage Variation with Source Current and Temperature.

Typical Characteristics

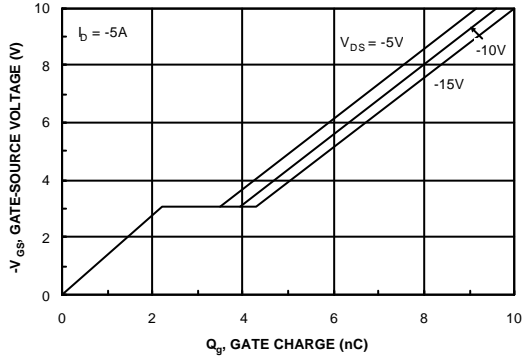

Figure 7. Gate Charge Characteristics.

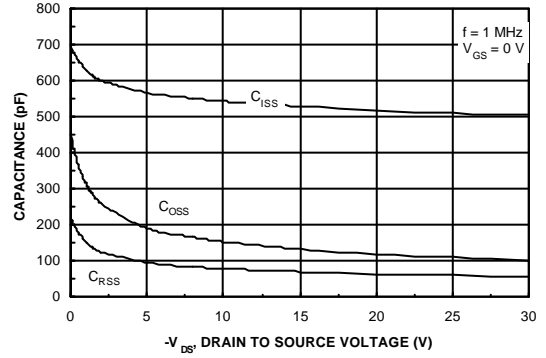

Figure 8. Capacitance Characteristics.

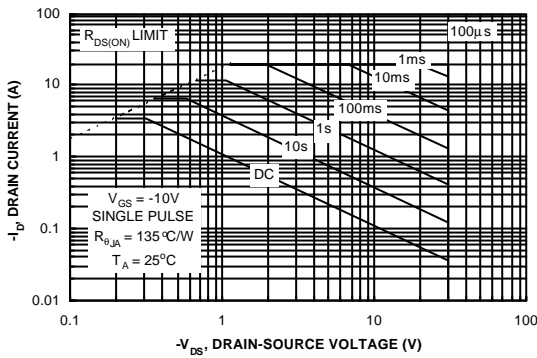

Figure 9. Maximum Safe Operating Area.

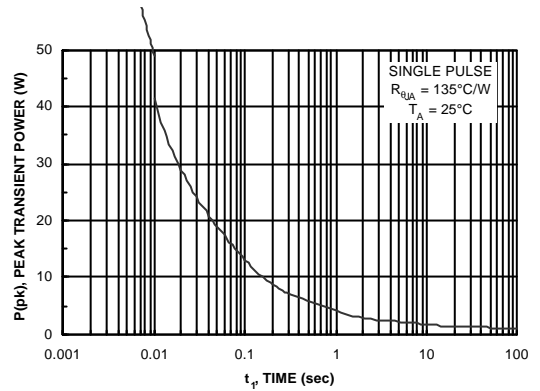

Figure 10. Single Pulse Maximum Power Dissipation.

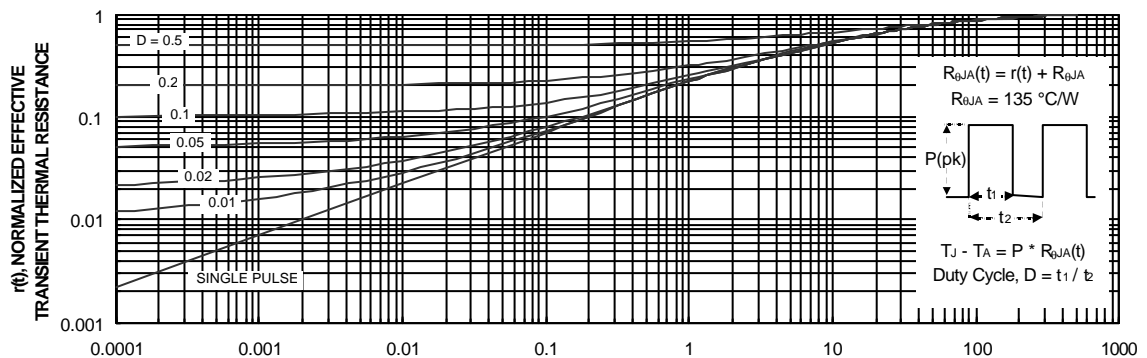
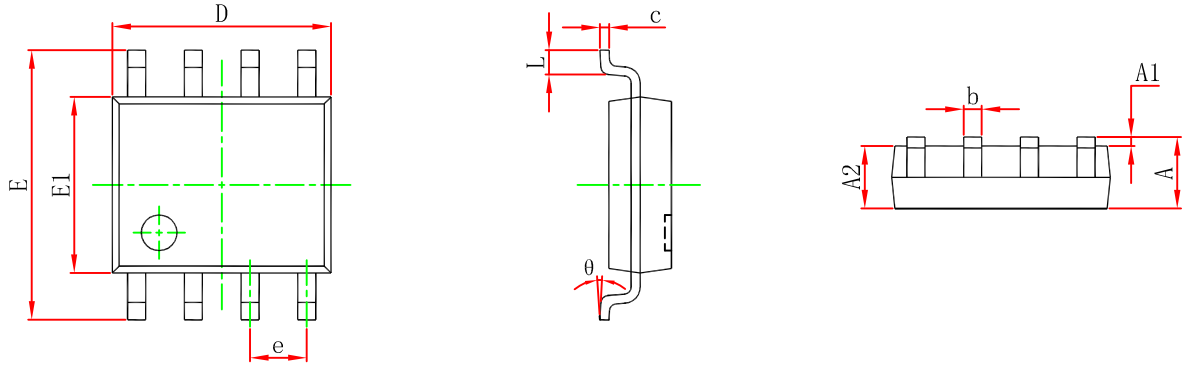

Figure 11. Transient Thermal Response Curve.

Thermal characterization performed using the conditions described in Note 1c. Transient thermal response will change depending on the circuit board design.

SOP8 Package Outline Dimensions



Symbol	Dimensions In Millimeters		Dimensions In Inches	
	Min	Max	Min	Max
A	1.350	1.750	0.053	0.069
A1	0.100	0.250	0.004	0.010
A2	1.350	1.550	0.053	0.061
b	0.330	0.510	0.013	0.020
c	0.170	0.250	0.007	0.010
D	4.800	5.000	0.189	0.197
e	1.270 (BSC)		0.050 (BSC)	
E	5.800	6.200	0.228	0.244
E1	3.800	4.000	0.150	0.157
L	0.400	1.270	0.016	0.050
θ	0°	8°	0°	8°

SOP8 Suggested Pad Layout

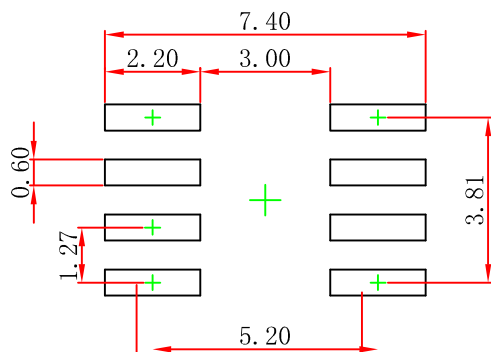

- Note:
1. Controlling dimension: in millimeters.
 2. General tolerance: $\pm 0.05\text{mm}$.
 3. The pad layout is for reference purposes only.