

# SOT-23 Plastic-Encapsulate MOSFETS

SI3401

## SI3401 P-Channel 30-V(D-S) MOSFET

$V_{(BR)DSS}$	$R_{DS(on)MAX}$	$I_D$
-30V	0.060Ω@-10V	-4.0A
	0.070Ω@-4.5V	
	0.100Ω@-2.5V	

### General FEATURE

- TrenchFET Power MOSFET
- Lead free product is acquired
- Surface mount package

### APPLICATION

- Load Switch for Portable Devices
- DC/DC Converter

### SOT-23

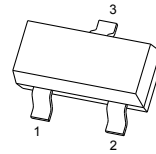

- 1.GATE
- 2.SOURCE
- 3.DRAIN

### MARKING

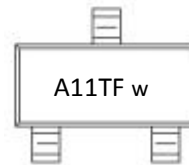

\*w: week code

### Equivalent Circuit

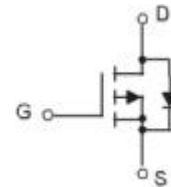

### Maximum ratings ( $T_a=25^{\circ}\text{C}$ unless otherwise noted)

Parameter	Symbol	Value	Unit
Drain-Source Voltage	$V_{DS}$	-30	V
Gate-Source Voltage	$V_{GS}$	±12	
Continuous Drain Current	$I_D$	-4.0	A
Pulsed Drain Current	$I_{DM}$	-25	
Maximum Power Dissipation	$P_D$	1.2	W
Thermal Resistance from Junction to Ambient( $t \leq 5s$ )	$R_{\theta JA}$	104	$^{\circ}\text{C/W}$
Junction Temperature	$T_J$	150	$^{\circ}\text{C}$
Storage Temperature	$T_{stg}$	-55 ~+150	

# SOT-23 Plastic-Encapsulate MOSFETS

**SI3401**

## MOSFET ELECTRICAL CHARACTERISTICS

**T<sub>a</sub> = 25 °C unless otherwise specified**

Parameter	Symbol	Test Condition	Min	Typ	Max	Units
<b>Static characteristics</b>						
Drain-source breakdown voltage	BV <sub>DSS</sub>	V <sub>GS</sub> = 0V, I <sub>D</sub> = -250μA	-30			V
Zero gate voltage drain current	I <sub>DSS</sub>	V <sub>DS</sub> = -24V, V <sub>GS</sub> = 0V			-1	μA
Gate-source leakage current	I <sub>GSS</sub>	V <sub>GS</sub> = ±12V, V <sub>DS</sub> = 0V			±100	nA
Drain-source on-resistance (note a)	R <sub>DS(on)</sub>	V <sub>GS</sub> = -10V, I <sub>D</sub> = -4.0A		55	60	mΩ
		V <sub>GS</sub> = -4.5V, I <sub>D</sub> = -3.5A		65	70	mΩ
		V <sub>GS</sub> = -2.5V, I <sub>D</sub> = -1.2A		95	100	mΩ
Forward tranconductance (note a)	g <sub>FS</sub>	V <sub>DS</sub> = -5V, I <sub>D</sub> = -4.0A	7	10		S
Gate threshold voltage	V <sub>GS(th)</sub>	V <sub>DS</sub> = V <sub>GS</sub> , I <sub>D</sub> = -250μA	-0.6	-1	-1.2	V
Diode forward voltage (note a)	V <sub>SD</sub>	I <sub>S</sub> = -1A, V <sub>GS</sub> = 0V			-1.2	V
<b>Dynamic characteristics (note b)</b>						
Input capacitance	C <sub>iss</sub>	V <sub>DS</sub> = -15V, V <sub>GS</sub> = 0V, f = 1MHz		950		pF
Output capacitance	C <sub>oss</sub>			115		pF
Reverse transfer capacitance	C <sub>rss</sub>			75		pF
<b>Switching Characteristics (note b)</b>						
Turn-on delay time	t <sub>d(on)</sub>	V <sub>GS</sub> = -10V, V <sub>DS</sub> = -15V, I <sub>D</sub> = -4.0A, R <sub>GEN</sub> = 6Ω		7.0		ns
Turn-on rise time	t <sub>r</sub>			3.0		ns
Turn-off delay time	t <sub>d(off)</sub>			30		ns
Turn-off fall time	t <sub>f</sub>			12		ns

**Notes:**

- a. Pulse Test : Pulse Width < 300μs, Duty Cycle ≤ 2%.  
 b. These parameters have no way to verify.

# SOT-23 Plastic-Encapsulate MOSFETS

SI3401

## Typical Electrical and Thermal Characteristics

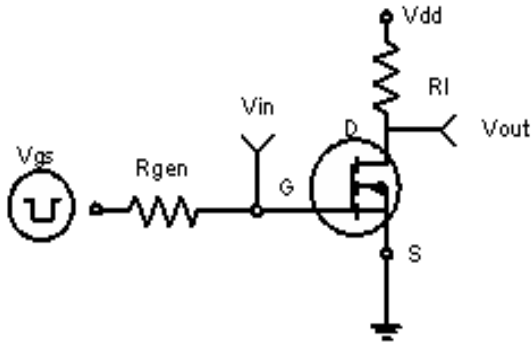

Figure 1: Switching Test Circuit

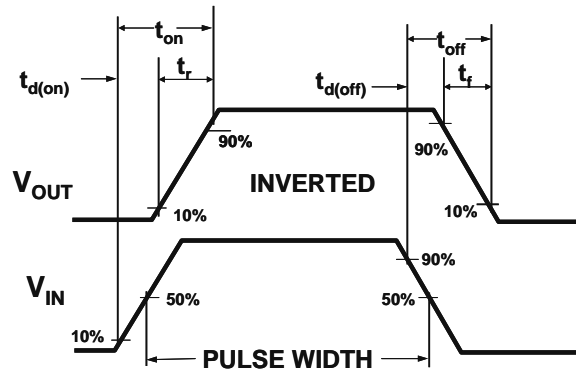
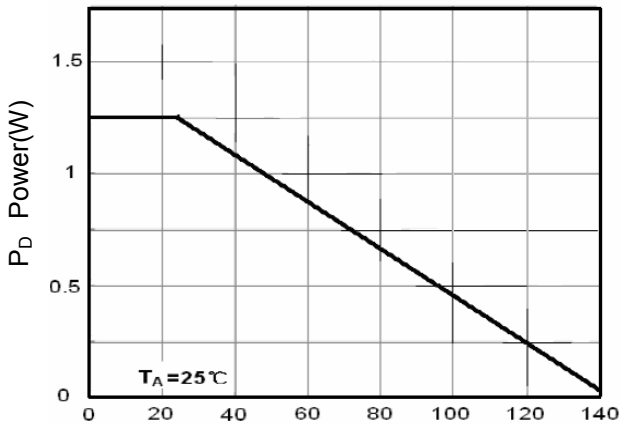
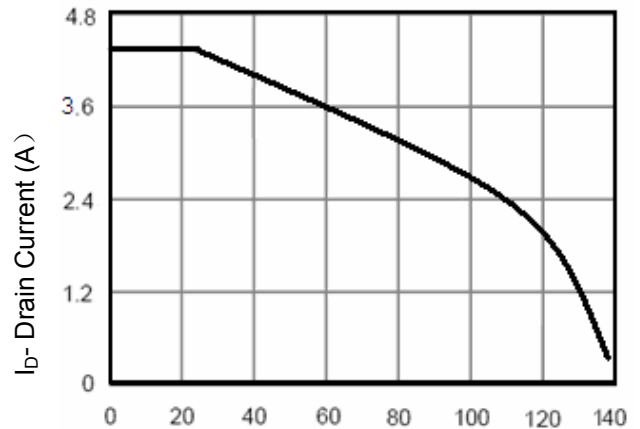

Figure 2: Switching Waveforms



T<sub>J</sub>-Junction Temperature(°C)  
Figure 3 Power Dissipation



T<sub>J</sub>-Junction Temperature(°C)  
Figure 4 Drain Current

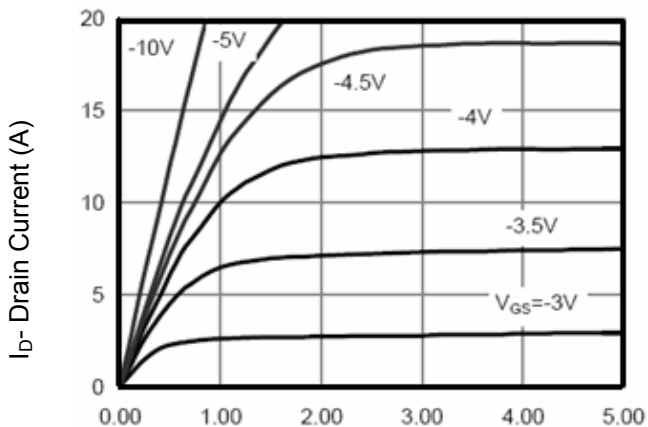

V<sub>ds</sub> Drain-Source Voltage (V)  
Figure 5 Output Characteristics

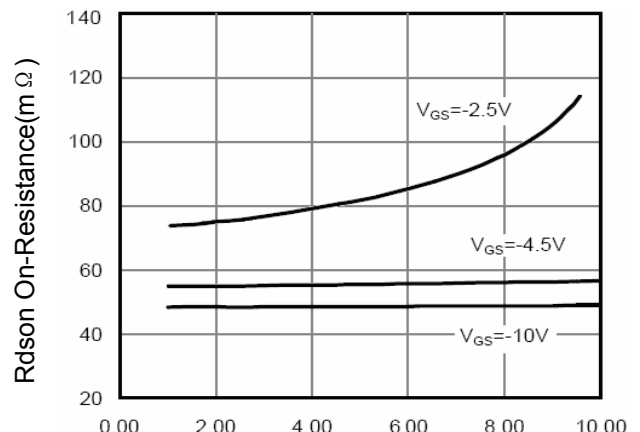

I<sub>D</sub>- Drain Current (A)  
Figure 6 Drain-Source On-Resistance

# SOT-23 Plastic-Encapsulate MOSFETS

SI3401

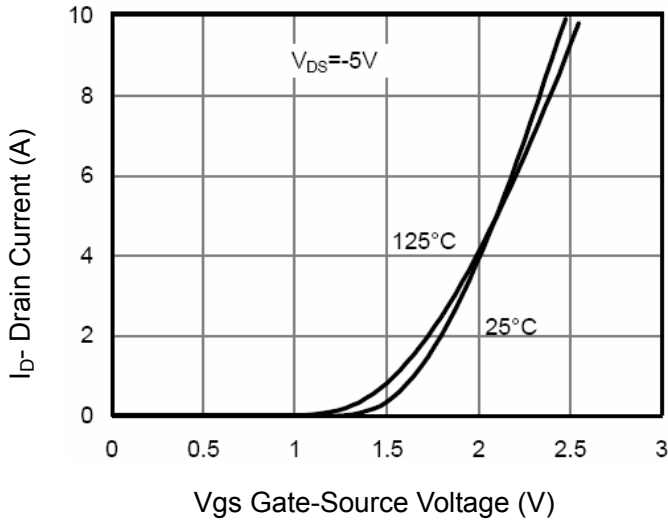

Figure 7 Transfer Characteristics

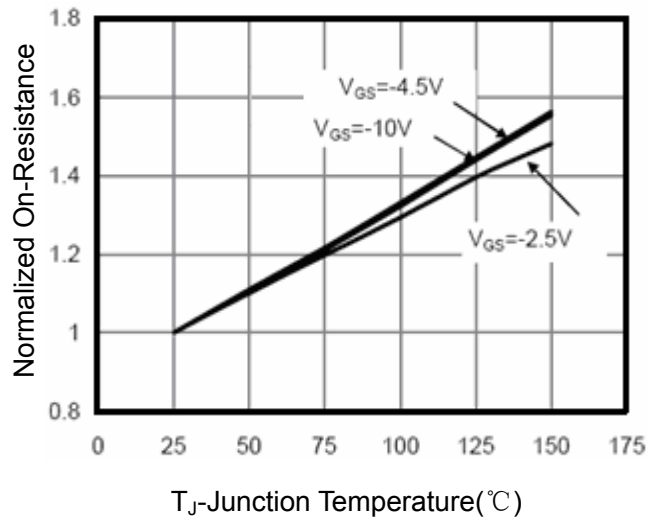

Figure 8 Drain-Source On-Resistance

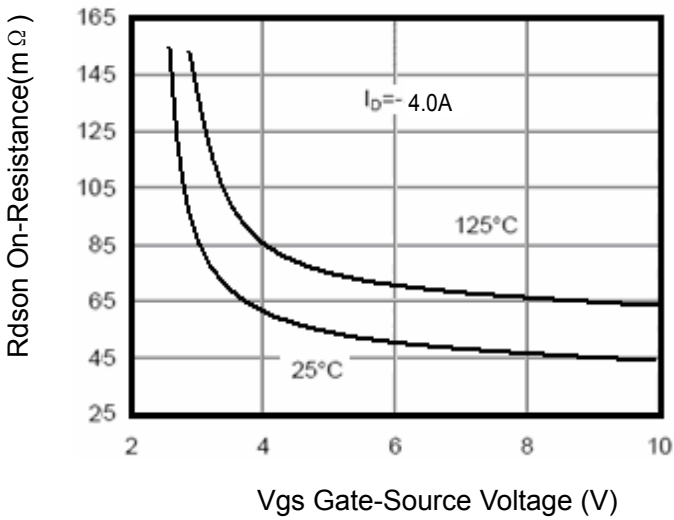

Figure 9 Rds(on) vs Vgs

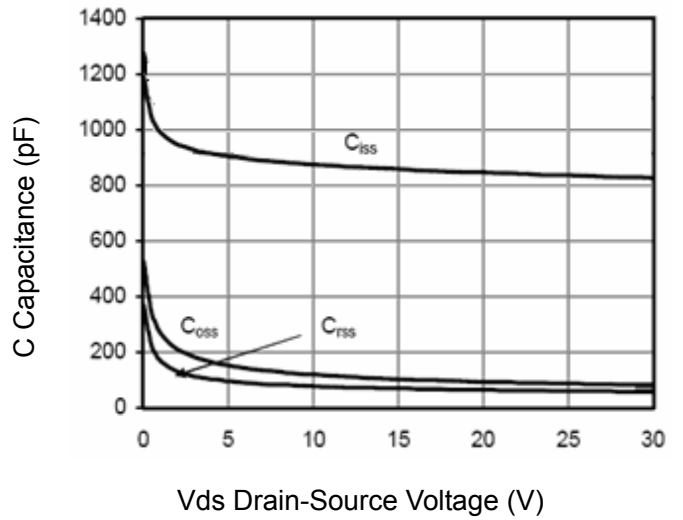

Figure 10 Capacitance vs Vds

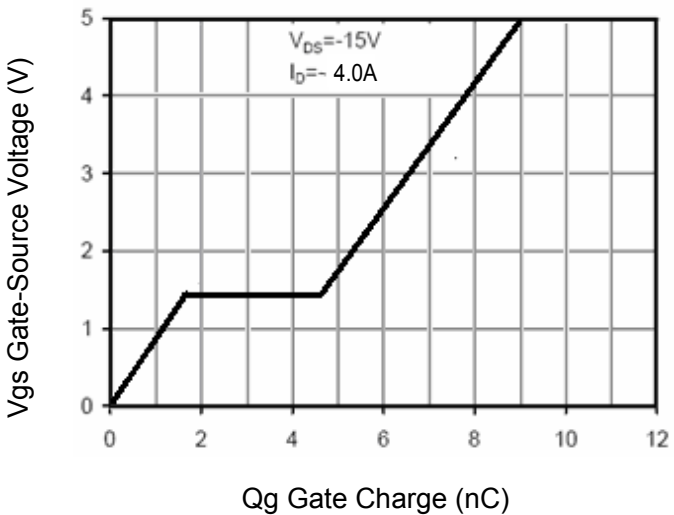

Figure 11 Gate Charge

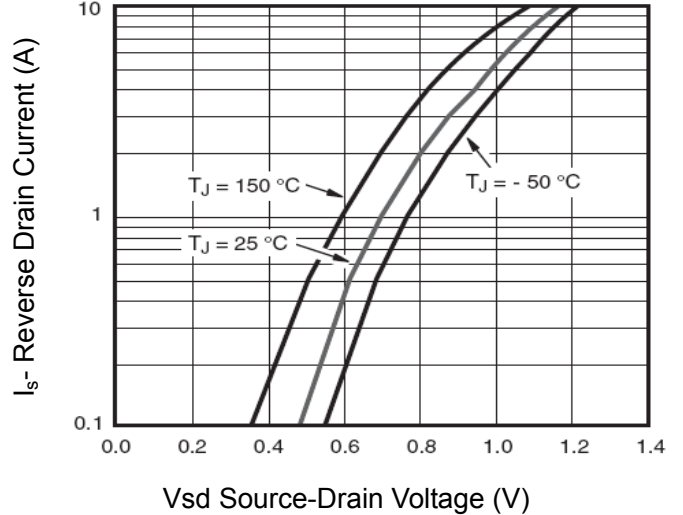
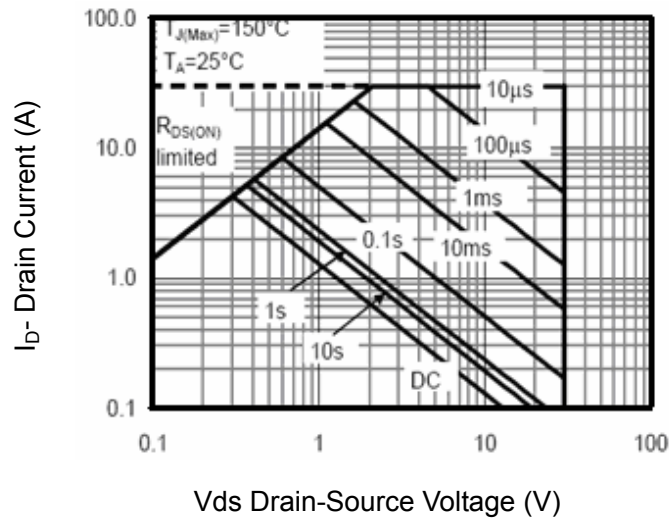

Figure 12 Source- Drain Diode Forward

# SOT-23 Plastic-Encapsulate MOSFETS

SI3401



Vds Drain-Source Voltage (V)  
Figure 13 Safe Operation Area

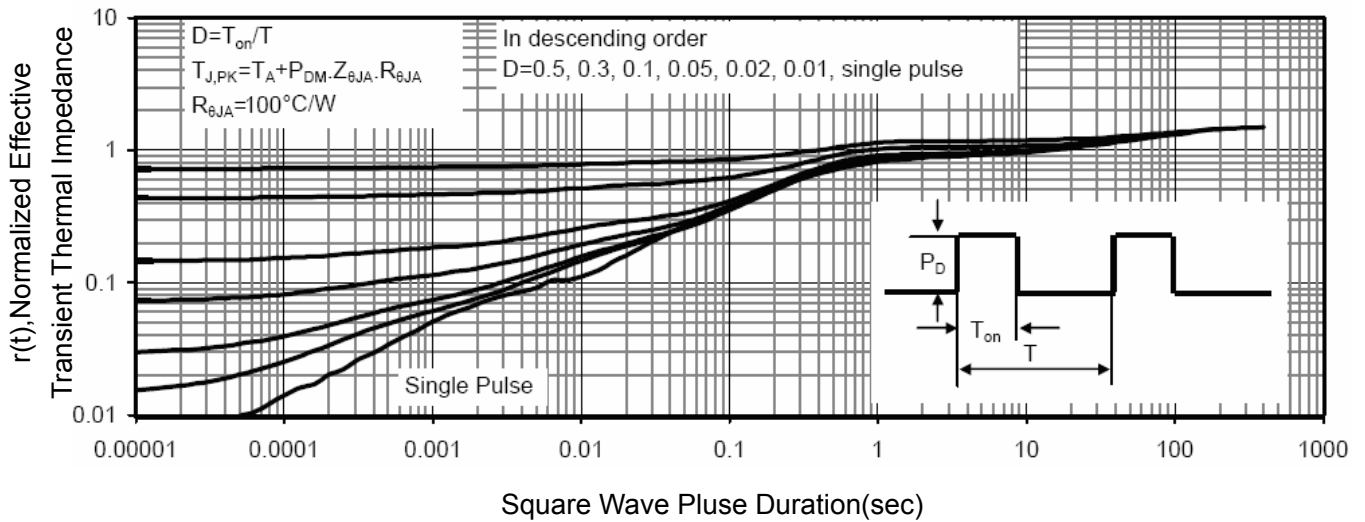

Square Wave Pulse Duration(sec)  
Figure 14 Normalized Maximum Transient Thermal Impedance

# SOT-23 Plastic-Encapsulate MOSFETS

SI3401

## SOT-23 Package Outline Dimensions

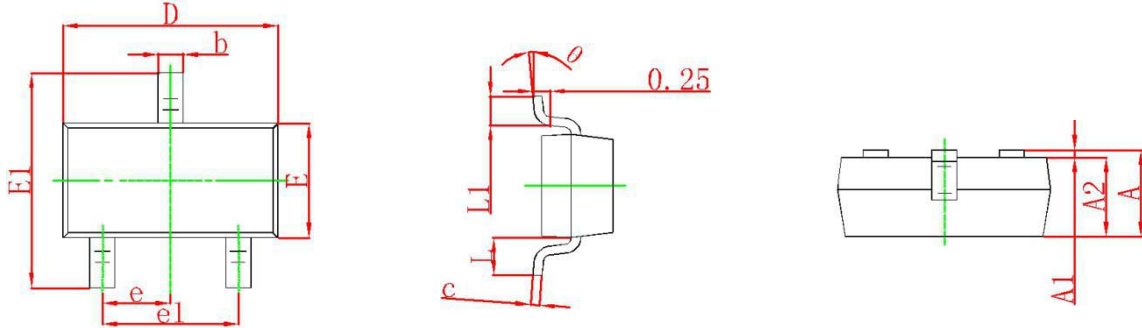

Symbol	Dimensions In Millimeters		Dimensions In Inches	
	Min	Max	Min	Max
A	0.900	1.150	0.035	0.045
A1	0.000	0.100	0.000	0.004
A2	0.900	1.050	0.035	0.041
b	0.300	0.500	0.012	0.020
c	0.080	0.150	0.003	0.006
D	2.800	3.000	0.110	0.118
E	1.200	1.400	0.047	0.055
E1	2.250	2.550	0.089	0.100
e	0.950 TYP		0.037 TYP	
e1	1.800	2.000	0.071	0.079
L	0.550 REF		0.022 REF	
L1	0.300	0.500	0.012	0.020
$\theta$	0°	8°	0°	8°

## SOT-23 Suggested Pad Layout

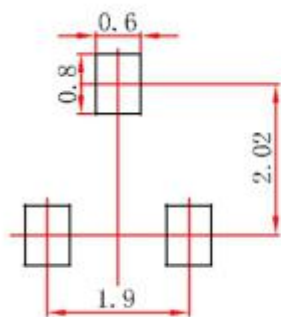

Note:

1. Controlling dimension: in millimeters.
2. General tolerance:  $\pm 0.05\text{mm}$ .
3. The pad layout is for reference purposes only.